



Drawer Partition Kitchen



Quick Overview

- Organize drawers as desired with flexible / modular drawer partitions.
- Comes flat packed with divider profiles and connectors â easy do-it-yourself and fun assembly.
- Can be easily positioned on the side or in the middle of drawer, multiple divider sets can be used in the same drawer depending on the size of the drawer.
- Ideal for storing multiple items such as cutlery, large knives, condiments, etc
- For best results â use with our anti-skid mat, also available on this website.
- Finish: Anthracite.
- Also available on this website: Drawer Partitions for Wardrobes in Mocha finish.

Kitchen Drawer Rack Size

2048-A 200 x 475

2048-B 200 x 475

3048-A 300 x 475

3048-B 300 x 475

4048-A 400 x 475

4048-B 400 x 475

Color

Specification

Model	Code	Size(mm)	Finish
Drawer Partition Kitchen	DPK-2048-A-AT	200 x 475	Anthracite
	DPK-2048-B-AT		
	DPK-3048-A-AT	300 x 475	
	DPK-3048-B-AT		
	DPK-4048-A-AT	400 x 475	
	DPK-4048-B-AT		

Fitting Instructions

DPK 2048 - A

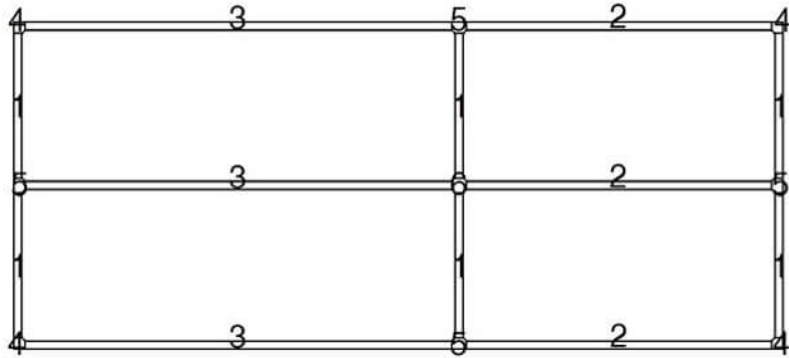
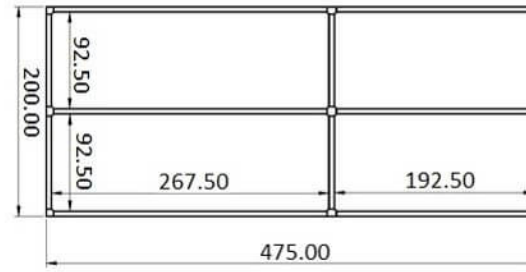
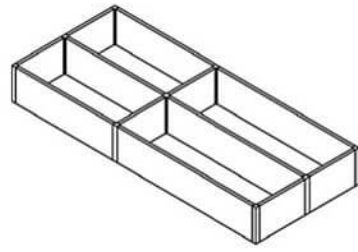
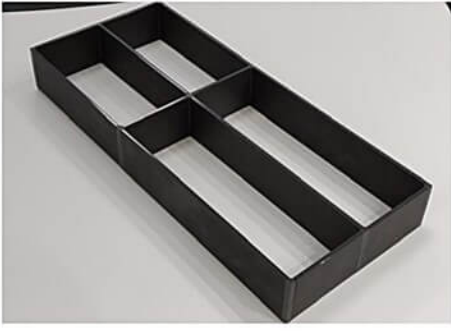

Description : DRAWER PARTITION - KITCHEN 200 x 475 - A			
PACKING LIST			
DTL. NO. SHOWN IN DRG	DESCRIPTION	SIZE / Pc.	QTY.
1	DRAWER PARTITION	88.50 x 60	6
2	DRAWER PARTITION	188.50 x 60	3
3	DRAWER PARTITION	263.50 x 60	3
4	DUAL CONNECTORS	60 D	4
5	TRI CONNECTORS	60 T	4
6	QUAD CONNECTORS	60 Q	1

DPK 2048 - B

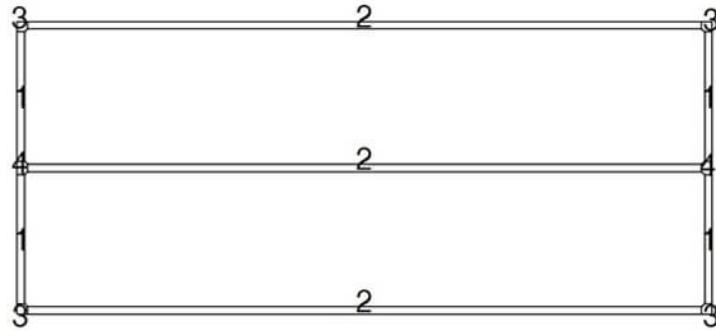
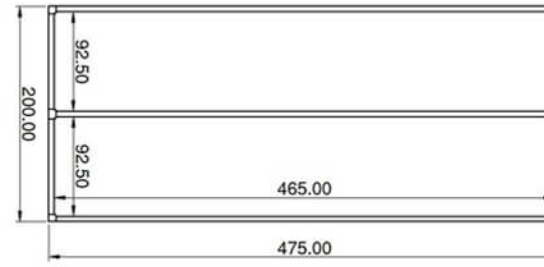
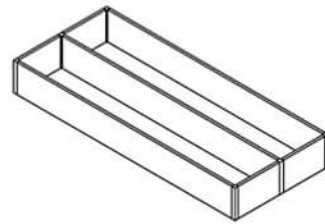

Description : DRAWER PARTITION - KITCHEN 200 x 475 - B			
PACKING LIST			
DTL. NO. SHOWN IN DRG	DESCRIPTION	SIZE / Pc.	QTY.
1	DRAWER PARTITION	88.50 x 60	4
2	DRAWER PARTITION	461.00 x 60	3
3	DUAL CONNECTORS	60 D	4
4	TRI CONNECTORS	60 T	2

DPK 3048 - A

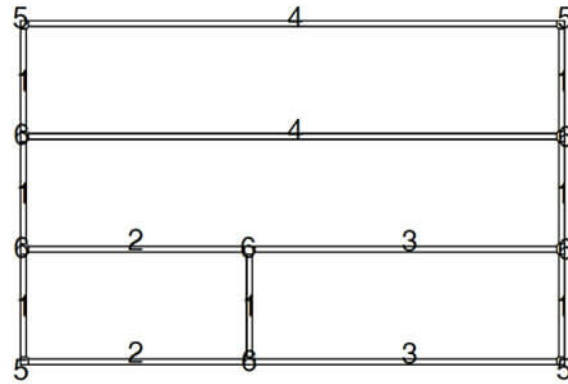
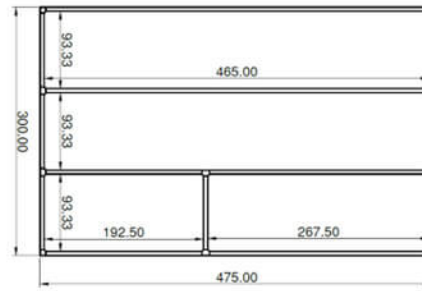
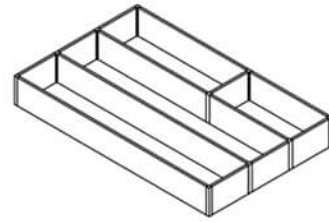
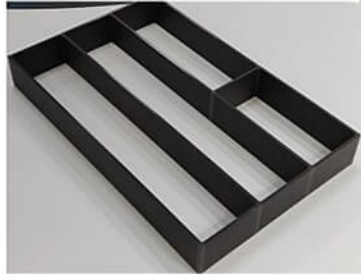

Description : DRAWER PARTITION - KITCHEN 300 x 475 - A

PACKING LIST

DTL. NO. SHOWN IN DRG	DESCRIPTION	SIZE / Pc.	QTY.
1	DRAWER PARTITION	89.33 x 60	7
2	DRAWER PARTITION	188.50 x 60	2
3	DRAWER PARTITION	263.50 x 60	2
4	DRAWER PARTITION	461.00 x 60	2
5	DUAL CONNECTORS	60 D	4
6	TRI CONNECTORS	60 T	6

DPK 3048 - B

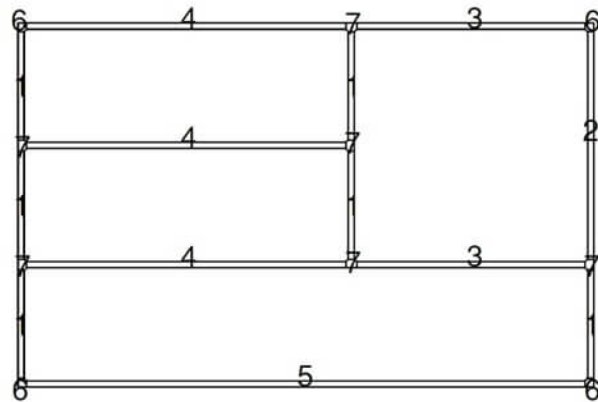
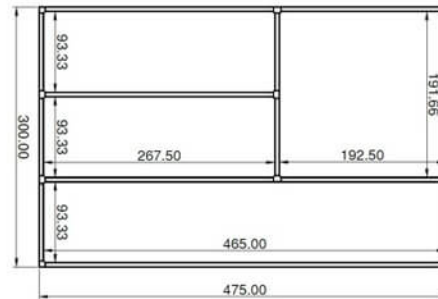
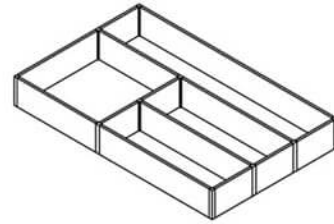
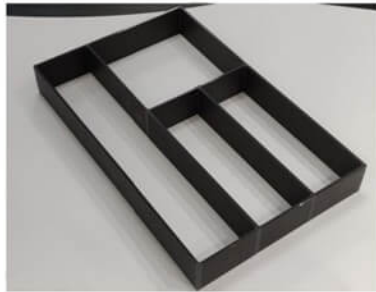

Description : DRAWER PARTITION - KITCHEN 300 x 475 - B

PACKING LIST

DTL. NO. SHOWN IN DRG	DESCRIPTION	SIZE / Pc.	QTY.
1	DRAWER PARTITION	89.33 x 60	6
2	DRAWER PARTITION	187.66 x 60	1
3	DRAWER PARTITION	188.50 x 60	2
4	DRAWER PARTITION	263.50 x 60	3
5	DRAWER PARTITION	461.00 x 60	1
6	DUAL CONNECTORS	60 D	4
7	TRI CONNECTORS	60 T	6

DPK 4048 - A

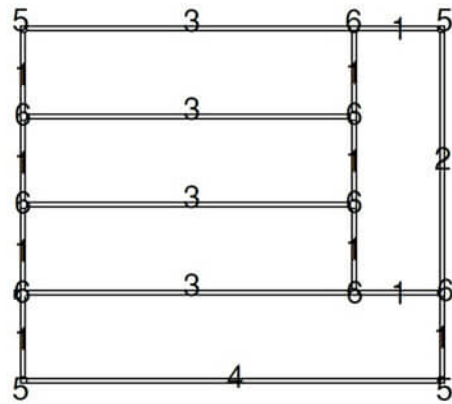
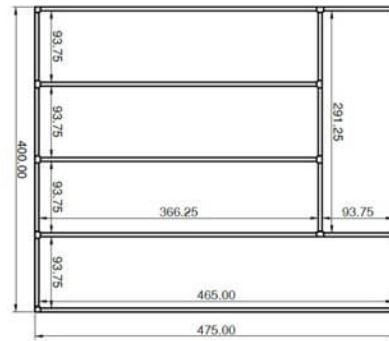
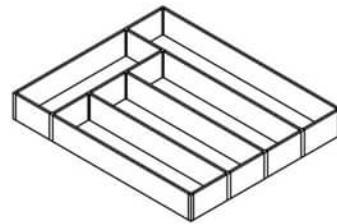
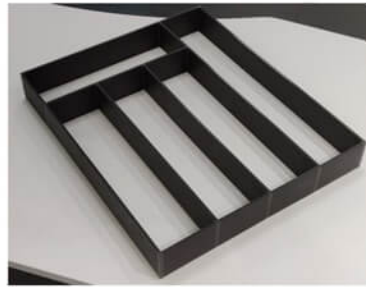

Description : DRAWER PARTITION - KITCHEN 400 x 475 - A			
PACKING LIST			
DTL. NO. SHOWN IN DRG	DESCRIPTION	SIZE / Pc.	QTY.
1	DRAWER PARTITION	89.75 x 60	10
2	DRAWER PARTITION	287.25 x 60	1
3	DRAWER PARTITION	362.25 x 60	4
4	DRAWER PARTITION	461.00 x 60	1
5	DUAL CONNECTORS	60 D	4
6	TRI CONNECTORS	60 T	8

DPK 4048 - B

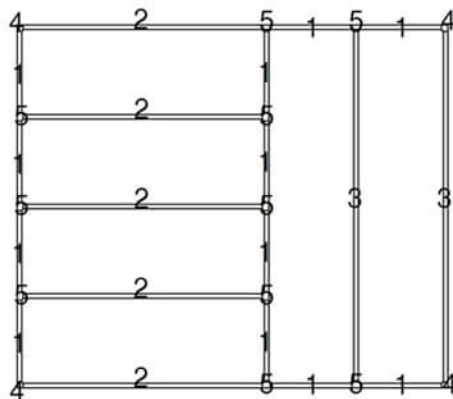
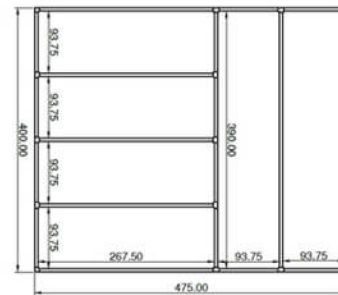
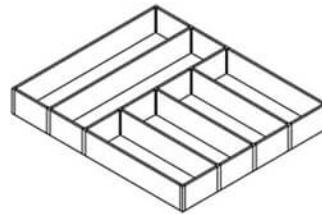

Description : DRAWER PARTITION - KITCHEN 400 x 475 - B			
PACKING LIST			
DTL. NO. SHOWN IN DRG	DESCRIPTION	SIZE / Pc.	QTY.
1	DRAWER PARTITION	89.75 x 60	12
2	DRAWER PARTITION	263.50 x 60	5
3	DRAWER PARTITION	386.00 x 60	2
4	DUAL CONNECTORS	60 D	4
5	TRI CONNECTORS	60 T	10

Care Instructions

- Wash and wipe dry.
- Do not paint, engrave or use any chemicals on the product.
- Do not use excessive force on the product as the dividers may bend and break if used roughly.
- Do not subject the product to temperatures in excess of 60 degrees Celsius â this may cause the product to deform.

Warranty

- Our Products comes with a 12 month warranty against any manufacturing defects.
- The warranty does not cover damages due to incorrect and inaccurate installation of the product.
- For any guidance or help required with installation, please email us at help@ebco.in with your order number and a scanned copy of the invoice.
- The warranty does not cover any usage of the product beyond its intended use and wear and tear in the natural course of product usage.
- The warranty is only valid against an original invoice received at the time of purchase.

Returns

- All sales are final, except in the case of any manufacturing defects. For any manufacturing defects, we offer easy replacements.
- In the case of transit damage, it rests solely at the discretion of Ebco to process any replacements on a case-by-case basis.
- In case, you receive a defective or damaged product , please contact us within 7 days of receipt. Email us a few photographs with the order number and a scanned copy of the invoice to help@ebco.in.
- We will assess the damage and revert within 24 hours. We will either arrange to collect the product and send you a replacement free of charge or just send you a replacement part.